

# TASCAM

TEAC Professional Division

# DA-88

Digital Multitrack Recorder



**OWNER'S MANUAL**

5700141001

## Important Safety Precautions



**CAUTION**  
RISK OF ELECTRIC SHOCK  
DO NOT OPEN



CAUTION: TO REDUCE THE RISK OF ELECTRIC SHOCK, DO NOT REMOVE COVER (OR BACK). NO USER-SERVICEABLE PARTS INSIDE. REFER SERVICING TO QUALIFIED SERVICE PERSONNEL.



The lightning flash with arrowhead symbol, within an equilateral triangle, is intended to alert the user to the presence of uninsulated "dangerous voltage" within the product's enclosure that may be of sufficient magnitude to constitute a risk of electric shock to persons.



The exclamation point within an equilateral triangle is intended to alert the user to the presence of important operating and maintenance (servicing) instructions in the literature accompanying the appliance.

This appliance has a serial number located on the rear panel. Please record the model number and serial number and retain them for your records.

Model number \_\_\_\_\_  
Serial number \_\_\_\_\_

**WARNING: TO PREVENT FIRE OR SHOCK HAZARD, DO NOT EXPOSE THIS APPLIANCE TO RAIN OR MOISTURE.**

For U.S.A.

### TO THE USER

This equipment has been tested and found to comply with the limits for a Class B digital device, pursuant to Part 15 of the FCC Rules. These limits are designed to provide reasonable protection against interference in a residential area. This device generates and uses radio frequency energy and if not installed and used in accordance with the instructions, it may cause interference to radio or TV reception. If this unit does cause interference with TV or radio reception you can try to correct the interference by one or more of the following measures:

- Reorient or relocate the receiving antenna.
  - Increase the separation between the equipment and the receiver.
  - Plug the equipment into a different outlet so that it is not on the same circuit as the receiver.
- If necessary, consult the dealer or an experienced radio/TV technician for additional suggestions.

#### CAUTION:

Changes or modifications to this equipment not expressly approved by TEAC CORPORATION for compliance could void the user's authority to operate this equipment.

THIS DIGITAL APPARATUS DOES NOT EXCEED THE CLASS B LIMITS FOR RADIO NOISE EMISSIONS FROM DIGITAL APPARATUS AS SET OUT IN THE RADIO INTERFERENCE REGULATIONS OF THE CANADIAN DEPARTMENT OF COMMUNICATIONS.

LE PRESENT APPAREIL NUMERIQUE N'EMET PAS DE BRUITS RADIOELECTRIQUES DEPASSANT LES LIMITES APPLICABLES AUX APPAREILS NUMERIQUES DE CLASSE B PRESCRITES DANS LE REGLEMENT SUR LE BROUILLAGE RADIOELECTRIQUE EDICTE PAR LE MINISTERE DES COMMUNICATIONS DU CANADA.

THE APPLIANCE CONFORMS WITH EEC DIRECTIVE 87/308/EEC REGARDING INTERFERENCE SUPPRESSION

CONFORME AL D.M. 13 APRILE 1989  
DIRETTIVA CEE/87/308

# SAFETY INSTRUCTIONS

## CAUTION:

- Read all of these instructions.
- Save these instructions for later use.
- Follow all warnings and instructions marked on the audio equipment.

1. **Read Instructions** – All the safety and operating instructions should be read before the appliance is operated.
2. **Retain Instructions** – The safety and operating instructions should be retained for future reference.
3. **Heed Warnings** – All warnings on the appliance and in the operating instructions should be adhered to.
4. **Follow Instructions** – All operating and use instructions should be followed.
5. **Water and Moisture** – The appliance should not be used near water – for example, near a bathtub, washbowl, kitchen sink, laundry tub, in a wet basement, or near a swimming pool, etc.
6. **Carts and Stands** – The appliance should be used only with a cart or stand that is recommended by the manufacturer.
- 6A. An appliance and cart combination should be moved with care. Quick stops, excessive force, and uneven surfaces may cause the appliance and cart combination to overturn.



7. **Wall or Ceiling Mounting** – The appliance should be mounted to a wall or ceiling only as recommended by the manufacturer.
8. **Ventilation** – The appliance should be situated so that its location or position does not interfere with its proper ventilation. For example, the appliance should not be situated on a bed, sofa, rug, or similar surface that may block the ventilation openings; or, placed in a built-in installation, such as a bookcase or cabinet that may impede the flow of air through the ventilation openings.
9. **Heat** – The appliance should be situated away from heat sources such as radiators, heat registers, stoves, or other appliances (including amplifiers) that produce heat.
10. **Power Sources** – The appliance should be connected to a power supply only of the type described in the operating instructions or as marked on the appliance.
11. **Grounding or Polarization** – The precautions that should be taken so that the grounding or polarization means of an appliance is not defeated.
12. **Power-Cord Protection** – Power-supply cords should be routed so that they are not likely to be walked on or pinched by items placed upon or against them, paying particular attention to cords at plugs, convenience receptacles, and the point where they exit from the appliance.

13. **Cleaning** – The appliance should be cleaned only as recommended by the manufacturer.
14. **Power Lines** – An outdoor antenna should be located away from power lines.
15. **Outdoor Antenna Grounding** – If an outside antenna is connected to the receiver, be sure the antenna system is grounded so as to provide some protection against voltage surges and built up static charges. Section 810 of the National Electrical Code, ANSI/NFPA No. 70 – 1984, provides information with respect to proper grounding of the mast and supporting structure, grounding of the lead-in wire to an antenna discharge unit, size of grounding conductors, location of antenna-discharge unit, connection to grounding electrodes, and requirements for the grounding electrode. See Figure below.

EXAMPLE OF ANTENNA GROUNDING  
AS PER NATIONAL  
ELECTRICAL CODE

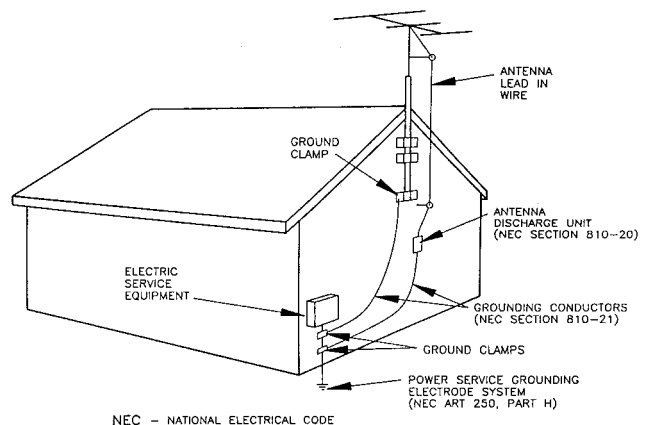

16. **Nonuse Periods** – The power cord of the appliance should be unplugged from the outlet when left unused for a long period of time.
17. **Object and Liquid Entry** – Care should be taken so that objects do not fall and liquids are not spilled into the enclosure through openings.
18. **Damage Requiring Service** – The appliance should be serviced by qualified service personnel when:
  - A. The power-supply cord or the plug has been damaged; or
  - B. Objects have fallen, or liquid has been spilled into the appliance; or
  - C. The appliance has been exposed to rain; or
  - D. The appliance does not appear to operate normally or exhibits a marked change in performance; or
  - E. The appliance has been dropped, or the enclosure damaged.
19. **Servicing** – The user should not attempt to service the appliance beyond that described in the operating instructions. All other servicing should be referred to qualified service personnel.

# Introduction

---

The TASCAM DA-88 is a digital audio multitrack recorder designed for use in a variety of professional applications. It records 8 channels of digital audio data on a readily available standard Hi8 video cassette tape which is comparable in handiness and compactness to conventional analog audio cassette tapes. Other features of the DA-88 include the following :

- Newly developed TASCAM-exclusive high performance/high wear resistive rotary 4-head mechanism with TASCAM original track layout.
- Synchronization of up to 16 DA-88s for a setup of 128 tracks simply by connecting them in series, without having to use any synchronizer-controller.
- Synchronization with video or other audio recorders (analog or digital) under SMPTE/EBU time code control when the optional SY-88 Sync Board is installed.
- Analog inputs and outputs handled by both RCA jacks (unbalanced) and 25-pin D-sub connectors (balanced), and digital inputs and outputs by a 25-pin serial I/O port.
- CD quality sound ensured by 16-bit linear quantization and 48/44.1 kHz sampling rate.
- Auto punch-in/out with rehearsal capability
- 2-point autolocator
- Variable speed playback (up to 6.0% in 0.1 % steps)

## Backup Feature

The following are retained in a backup memory each time the power is turned off (battery life is about 50,000 hours) :

- MEMO 1 and 2 points
- Pitch change
- Offset time
- Track delay time
- Crossfade time
- Punch-in and out points
- Preroll time
- DIGITAL IN on/off
- Monitor selection (ALL INPUT, AUTO INPUT and INSERT)
- CHASE on/off
- CLOCK selection

## TABLE OF CONTENTS

<b>Important Safety Precautions</b> .....	2
<b>Safety Instructions</b> .....	3
<b>Introduction</b> .....	4
<b>Precautions and Recommendations</b> .....	5
<b>Specifications</b> .....	6
<b>Optional Accessories</b> .....	6
<b>Features and Controls</b> .....	7-12
Front Panel.....	8
Rear Panel.....	11
<b>Note for U.K. Customers</b> .....	12
<b>Hookup</b> .....	13
<b>Formatting a Tape</b> .....	13-14
<b>Audio Record and Playback</b> .....	15-21
Initial Recording.....	14
Punch-in (Insert) Recording.....	16
Bouncing Tracks (Ping-pong).....	20
Entering a Track Delay Time.....	21
<b>Variable Speed Playback</b> .....	21
<b>Autolocation Controls</b> .....	22-23
Setting Locating Points.....	22
Repeat Play.....	22
<b>Multiple-DA-88 System</b> .....	23-25
Synchronization.....	23
Entering an Offset.....	24
Digital Dubbing.....	25
<b>Error Messages</b> .....	26

## □ Using this manual

Before actually using the DA-88, please read this manual thoroughly at least once, so you will know where to return when you need answers. Even though a quick glance will get you going, careful study will ensure that misunderstandings won't slow you down.

**Use of capital letters** : In general, we use all upper case type to designate a particular switch, control or connector label, as in : Hold RECORD and press PLAY.

## Precautions and Recommendations

### □ Environmental conditions

The DA-88 may be used in most area, but to maintain top performance and prolong operating life, observe the following environmental limitations :

- 1) Nominal temperature should be 5 to 35 degrees Celsius (41 to 95 degrees Fahrenheit).
  - 2) Relative humidity should be 30 to 90% (non-condensing).
  - 3) Strong magnetic fields should not exist nearby.
- Install the unit in an area with proper ventilation.

**Beware of Condensation :** When the DA-88 is moved from a cold to a warm place or used after sudden temperature change, there is the danger of condensation ; water vapor in the air could condense on the internal mechanism, making correct operation impossible and causing damage to the tape. If condensation occurs, and you attempt to load a tape, this will automatically be ejected. To prevent this, if you are going to use the unit in a condition where condensation could occur, leave the unit for 1 or 2 hours with the power turned on, then turn the power off before turning it on again. Do the same when condensation has occurred too.

### □ Recommended tapes

The DA-88 transport mechanism is aligned prior to shipment for SONY Hi8 tapes (MP and ME) to provide optimum recording and playback performance. As of October 1993 the following brands and types of Hi8 tape have proved satisfactory in operation.

MP: SONY, TDK, FUJI, BASF, 3M, DENON,  
KONICA

ME: SONY, TDK, MAXELL, BASF

TASCAM cannot assume responsibility for problems which may arise from inconsistencies in tape or shell manufacturing quality. Frequent illumination of the DA-88 ERROR LED may indicate the possible presence of tape-related dropouts. Should this occur we recommend that the tape in use be changed before recording continues.

#### CAUTION

Never use tapes longer than 120-minute tape of NTSC (P6-120, E6-120) or 90-minute tape of PAL/SECAM (P5-90, E5-90). Also never use tapes which have been used previously for video recording.

- The DA-88 senses the thickness of tapes inserted, and if you attempt to load longer tapes than P6-150/E6-150 (NTSC) or P5-120/E5-120 (PAL/SECAM), they will automatically be ejected.

### □ Available record/play time

When used with the DA-88, Hi8 video tapes provide different record/play times depending on whether they are

designed for the NTSC or the PAL/SECAM television system, and therefore on the country where they are sold.

Labelled time	Actual, available time	
	P6/E6 (NTSC)	P5/E5 (PAL/SECAM)
20	18	25
30	27	37
45	40	56
60	54	75
90	81	113
120	108	—

P6/E6 or P5/E5 is labelled on the tape package.

### □ Cleaning the heads

After long periods of use, the heads may become dirty. They should be cleaned after every 50 hours (or so) of operation.

Be sure to use a *dry cleaning tape designed for 8 mm video*.

First, if the machine is turned on, turn it off.

1. Press and hold both the ▲ and ▼ keys and press the **POWER** switch.  
"CLEANing" will flash in the display to indicate that the machine is put into Cleaning mode.
  2. Insert your cleaning tape.  
Cleaning will start and, about 15 seconds later, the tape will automatically be ejected, the machine quitting the cleaning mode.
- You cannot let the cleaning tape run by means of any transport control buttons. Never try to rewind it for reuse by any means. Use a new cleaning tape only once thru.
  - Excessive cleaning causes premature wearing of the heads. Don't repeat cleaning 5 times or more at a stretch.
  - To maintain performance of the machine, besides head cleaning (50 hours), a routine maintenance check is recommended approximately every 500 hours.

### □ Others

- To avoid electric shock or other accidents, don't open the unit to clean inside or perform internal adjustments. The user should not attempt at any servicing which is not contained in this Owner's Manual.
- Before turning off the unit, be sure to remove the tape from the unit. Leaving it in the unit for a long time could cause damage to the tape.
- Don't cut tapes for any editing purposes. Such tapes could make correct operation impossible or result in accumulation of dirt on, or damage to, the heads.
- If a hum or ground loop develops, check the AC power connection. If necessary, consult a person familiar with studio grounding techniques.

## Specifications

### Transport

- Recording Format** : 4-rotary head digital recording
- Tape** : Hi8 video tape
- Number of Channels** : Eight plus subcode area
- Recording Time** : 108 minutes using P6/E6-120 tape/113 minutes using P5/E5-90 tape
- Tape Speed** : 15.9 mm per second
- Fast Forward/Rewind Time** : Approximately 80 seconds using P6/E6-120 tape/85 seconds using P5/E5-90 tape (100 times play speed)
- Shuttle Speed** : 1/4 to 8 times play speed

### Inputs and Outputs

- Digital I/O** : TDIF (TEAC Digital Interface Format), 25 pin D-sub x1
- Analog Input** : 25 pin D-sub connector x1, +4 dBm, 10k ohms (balanced)  
RCA jack x8, -10 dBV, 50k ohms (unbalanced)
- Output** : 25 pin D-sub connector x1, +4 dBm, 75 ohms (balanced)  
RCA jack x8, -10 dBV, 250 ohms (unbalanced)
- Sync Input** : 15 pin D-sub connector x1
- Output** : 15 pin D-sub connector x1
- Word Sync Input** : BNC connector x1
- Output** : BNC connector x 1
- Remote Input** : 8 pin DIN connector x1
- Remote Punch In/Out** : 1/4" phone jack x1

### Typical Performance

- Sampling Rate** : 44.1/48 kHz
- Quantization** : 16 bit linear
- Pitch Control** : +/-6% in 0.1% increments
- Frequency Response (Record and Play)** : 20 Hz to 20 kHz, +/-0.5 dB
- Dynamic Range** : Better than 92 dB
- Wow and Flutter** : Less than measurable limits
- Total Harmonic Distortion** : 0.007%

### General

- Power Requirements** :
  - USA/Canada** : 120 V AC, 60 Hz
  - Europe** : 230 V AC, 50 Hz
  - U.K./Australia** : 240 V AC, 50 Hz
- Consumption** : 74 Watts
- Dimensions (WxHxD)** : 482 mm x 176 mm x 377 mm
- Weight** : 14 kg

 *Changes in specifications and features may be made without notice or obligation.*

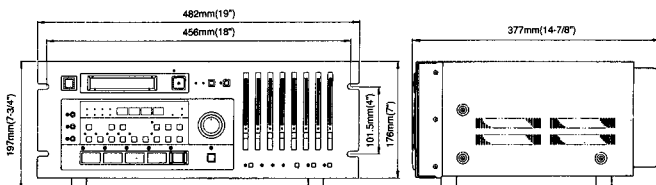

## Optional Accessories

- RC-848 Full-function Remote Control Unit**
  - 99-point autolocator functions
  - ACCESSORY 1 and 2 connectors for controlling TASCAM (or other) audio machines
  - RS-422 connector for controlling VT machines
  - Jog/shuttle wheel for locating a specific point at variable speeds
  - Keypad-entered time locations
  - Menu-selectable controls of the optional SY-88 synchronizer

- RC-808 Basic Transport Remote Control Unit**  
Has duplicates of REC FUNCTION, ALL INPUT, AUTO INPUT, REHEARSAL, AUTO IN/OUT, CLEAR, REPEAT, MEMO and LOC in addition to the transport controls.

- SY-88 Sync Board**
  - All SMPTE/EBU time codes supported : Drop 29.97 fps, Non Drop 29.97 fps, 30 fps, 25 fps (EBU), and 24 fps (Film).
  - Offset sync with sub-frame accuracy
  - Automatic offset entry

- PW-88S Sync Cable**  
For connecting multiple DA-88s in series when one serves as the master and others as slaves. One cable establishes connection between two DA-88s.

- PW-88D (1 m)/PW-88DL (5 m) Dubbing Cable**  
For connecting two DA-88s through their digital I/O port when one serves as the source machine and the other as the target.

- MU-8824 24-channel Meter Unit**  
Allows metering three DA-88s.

- PW-88M Meter Cable**  
For connecting the MU-8824 meter unit to the DA-88.

- IF-88AE Interface Unit**  
For data communication between the DA-88 and other digital machines with AES/EBU digital I/O or SPDIF.

- IF-88SD Interface Unit**  
For data communication between the DA-88 and other digital machines with SDIF-2.

- RC-30P Punch-in Footswitch**

# Features and Controls

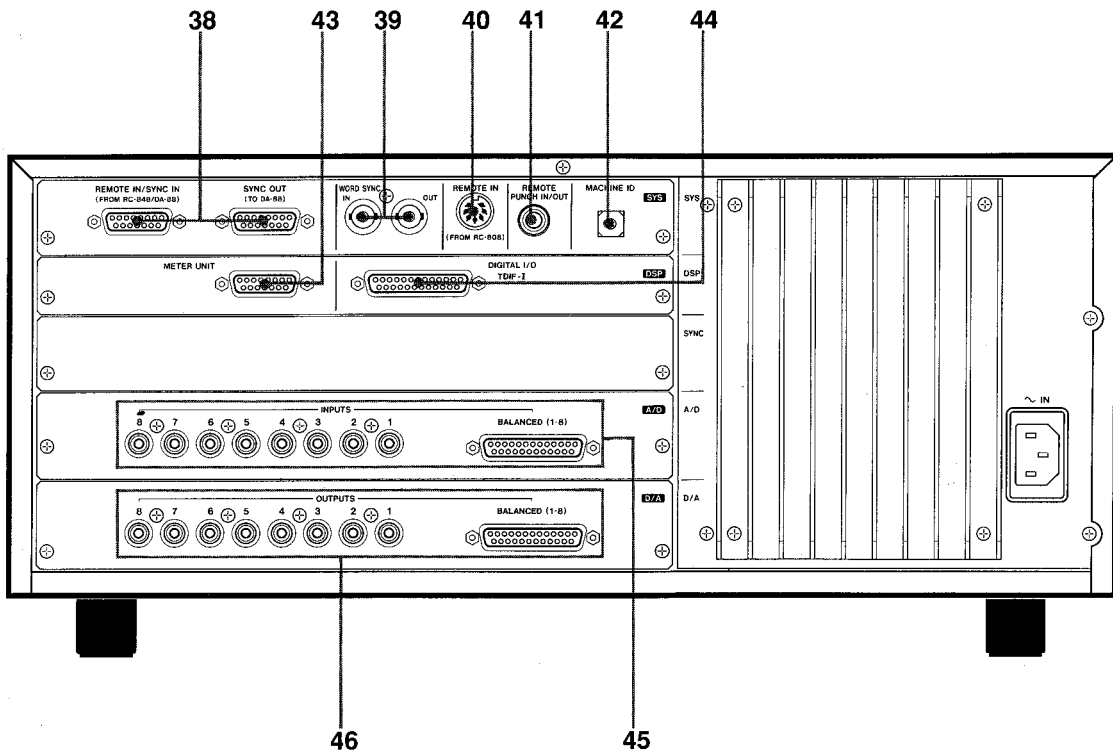
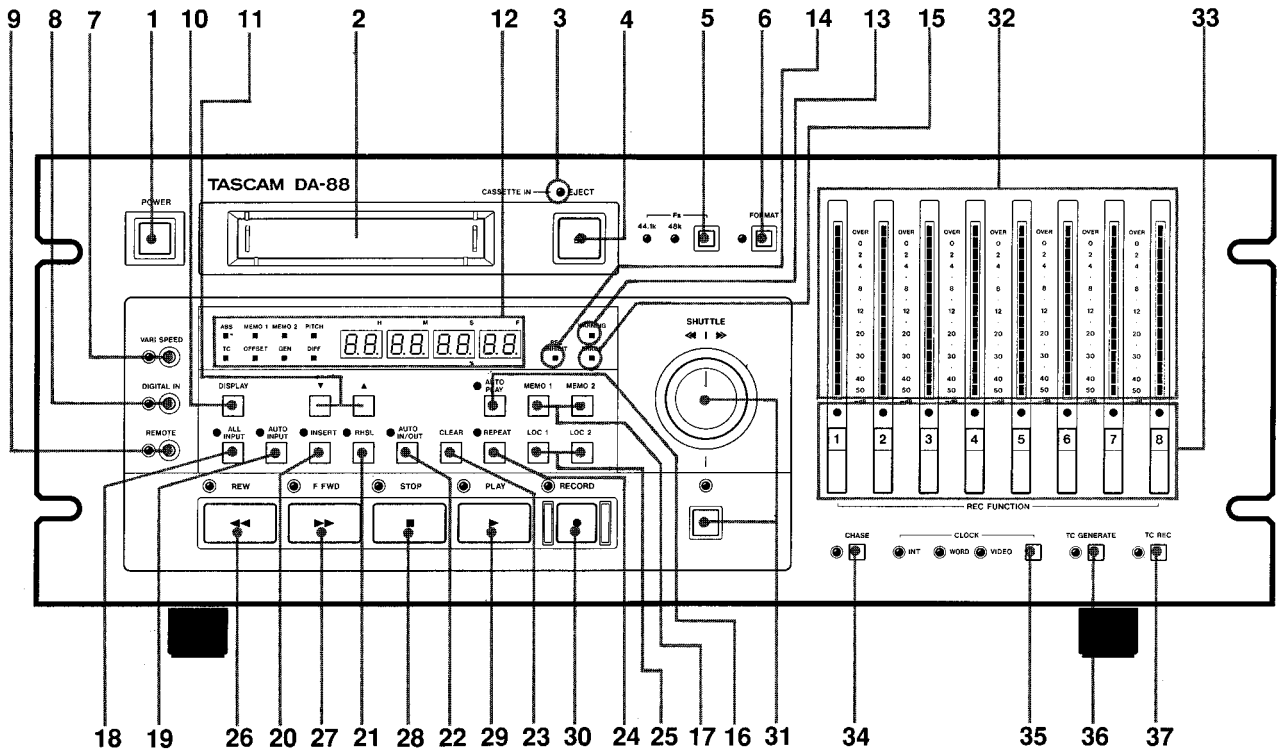

Skim through this section of the manual to get a bird's-eye-view of the DA-88, that way you will be able to locate information whenever you need. It is not necessary to memorize all what is here nor to try to build up details into a systematic whole to get started.

☞ *Functions available only when the optional SY-88 Sync Board is installed are not explained here. Information on them is provided in the SY-88's manual.*

## FRONT PANEL

### 1. POWER switch

Controls the power to the DA-88. See also page 4, "Backup Feature."

### 2. Tape loading window

#### NOTE

Don't use any Hi8 tape which was once used for video recording. No audio recording can correctly be made on such tapes.

### 3. CASSETTE IN LED

Lights when a cassette is inside the deck.

### 4. EJECT key

When pressed, the cassette is ejected.

EJECT can operate during stop only.

### 5. Fs (sampling frequency) switch

Toggles two sampling frequencies (or rates) for your choice. When formatting a tape you have to select 48 kHz or 44.1 kHz depending on the applications. During play the deck will automatically switch to the rate at which the recording was made, and either of the two LEDs will light accordingly.

#### NOTE

If you attempt to record additional material to augment the original one, and the incoming sampling rate is not the same as that is previously recorded on the tape, one of the Fs indicators will flash, warning you that recording cannot correctly be done.

### 6. FORMAT key

To format a tape is to record it with subcode data, of which ABS (absolute) time is one. This ABS data express the elapsed time from the beginning of the tape, not from any optionally selectable intermediate point : hence the name "absolute."

Formatting a tape erases whatever is previously recorded on it. To prevent formatting from starting accidentally, the FORMAT key is not actually activated unless you press it twice.

#### IMPORTANT

Audio can be recorded while formatting. But it's wise of you to format the tape from the beginning all the way to the end before recording audio. This insures against noise and discontinuity of absolute time data. If you want to record audio and format a tape at one time, don't stop recording by stopping the tape with STOP or PLAY. Press REC FUNCTION instead, which allows the tape to be continuously formatted up to the end.

### 7. VARI SPEED switch

When pressed, "PITCH" will show in the display and you can use the ▼ and ▲ keys to change the play (or the record) speed up to +/-6.0 % in 0.1 % steps.

#### CAUTION

The pitch change affects the record speed also. Check to see that the VARI SPEED LED is turned off unless you are using the function intentionally.

### 8. DIGITAL IN switch

Selects either the analog or the digital input. Pressing this switch to turn on its LED activates the DIGITAL I/O port. Turning off the LED selects the analog inputs (RCA jacks or multipin connector) as the source of the deck.

### 9. REMOTE switch

When this switch is pressed, and the associated LED lights, the DA-88 is submitted to the optional RC-848 remote control unit, and all controls are locked out except DISPLAY (item 10), ▼ and ▲ (item 11), and STOP.

### 10. DISPLAY switch

Each time you press this switch, the following will show in the digital display window in sequence, as confirmed by the corresponding LEDs being lit next to the display :

- (1) ABS (absolute) time (elapsed time from the beginning of the tape up to the current position)



- (2) MEMO 1 point
- (3) MEMO 2 point
- (4) % of pitch change

○ To go back to ABS time display mode quickly, you can hold DISPLAY and press ▲.

### 11. ▼ and ▲ keys

Used to enter the following :

- Crossfade time (p. 17);
- Offset time (p. 24);
- Track delay time (p. 21);
- Pitch change (p. 21);
- Preroll time (p.17).

The following can be trimmed or fine tuned with the ▼ and ▲ keys :

- MEMO points (p.22) ;
- Punch-in and out points (p.17).

The keys are also used together with DISPLAY to get access to :

- ABS time indication — if you hold DISPLAY and press ▲.
- Track delay time setting mode — if you hold ▲ and press DISPLAY.
- Crossfade time setting mode — if you hold ▼ and press DISPLAY.

### 12. Digital display window

Shows the ABS time, MEMO 1 point, MEMO 2 point, or amount of pitch change (or SMPTE time code numbers when the optional sync board is installed), as selected by the DISPLAY switch.

The display will also show error messages. For details on them, see page 26.

- The display can quickly be switched back to show ABS time when you hold DISPLAY and press ▲ at any time (except when error messages show).
- The ABS time display can flicker when the tape is fast winding (while in F.FWD, REW or LOC).

### 13. WARNING LED

Flashes to warn you that trouble occurred. Error messages will also then show in the display, specifying what is wrong. See also page 26.

### 14. REC INHIBIT LED

Lights when the tape in use is write-protected. Check the write protect tab on the cassette.

### 15. ERROR LED

Lights when errors occurred at so constraint a rate in digital data, that they cannot be corrected, and are submitted to interpolation to arrive at an approximation to the correct data.

This indicator also lights to indicate that dirt accumulates on the heads or tape paths, or that the tape is damaged. If another tape is loaded and the indicator does not turn off, consult TASCAM or your nearest TASCAM dealer.

See also the 3rd paragraph under the heading, Recommended tapes, on page 5.

### 16. AUTO PLAY key

Automates play start at the end of each autolocation function.

### 17. MEMO 1 and MEMO 2 keys

Pressing MEMO 1 stores the current tape location into that register, to which the tape will be autolocated when pressing LOC 1. MEMO 2 is similar to MEMO 1, and is used to capture any point to which you can return by pressing LOC 2.

#### NOTE

"MEMO" points you recall into the display by pressing DISPLAY are the points to which the tape will be autolocated when pressing LOC, except when RHSL lights solid. When RHSL lights solid, "MEMO 1" shows the punch-in point, and "MEMO 2" the punch-out point, as established during Rehearsal Setting mode (during which RHSL should blink). This does not mean that punch-in and out points are stored into the MEMO registers. When they are recalled into the display, the "MEMO 1" LED only indicates the punch-in point, and the "MEMO 2" LED the punch-out point.

### 18. ALL INPUT switch

When pressed to turn on its LED, all the channels' outputs are switched to carry signals derived from the inputs, whatever the transport mode (primarily for alignment).

**19. AUTO INPUT switch**

When this switch and INSERT are both previously activated, the channel inputs selected by REC FUNCTION are automatically switched to directly feed the outputs whenever the transport goes into rewind, fast-forward, shuttle, or stop mode. This allows the talent in studio to talk to the engineer in control room without having to change any settings on the mixer.

**20. INSERT switch**

Lets you monitor tape during preroll and postroll for punch-in recording. See table below.

**Relationships between the output signals, transport modes and switch settings**

ALL INPUT	REC FUNCTION	INSERT	AUTO INPUT	PLAY	RECORD	SHUTTLE	STOP
ON	/	/	/	INPUT			
OFF	ON	ON	ON	TAPE	INPUT		
		OFF	OFF	TAPE	INPUT	TAPE	—
	OFF	/	/	INPUT			
	OFF	/	/	TAPE			—

**21. RHSL switch**

Puts the deck into rehearsal mode which allows you to check the auto punch in and out points for accuracy.

**22. AUTO IN/OUT switch**

Automates the punch-in sequence (preroll, punch in, punch out, and postroll) as you have set during rehearsal.

**23. CLEAR key**

Defeats the RHSL and AUTO IN/OUT functions.

**24. REPEAT 1-2 switch**

Lets the tape play between two MEMO points.

**25. LOC 1 and LOC 2 keys**

LOC 1 locates the tape to the MEMO 1 point, and LOC 2 to the MEMO 2 point.

**26. REW key**

Winds the tape at high speed in reverse.

Pressing REW during recording punches out and the tape rewinds.

**27. F.FWD key**

Winds the tape at high speed in the forward direction.

Pressing F.FWD during recording punches out and the tape fast forwards.

- When you press F.FWD or REW for the first time after powering up or replacing the tape, this will run at an intermediate speed for a few seconds before starting running at the expected high speed. During this interval the transport is detecting the tape characteristics.

**28. STOP key**

Disables the current transport mode and stops any tape motion.

**29. PLAY key**

Enables play mode ; or, punches out of record if pressed during record.

**30. RECORD key**

Pressing PLAY while holding RECORD initiates record on any track whose REC FUNCTION indicator was blinking to show Record Ready mode.

Hitting RECORD during play lets any "Ready" track punch into record.

**31. SHUTTLE switch and the knob**

Pressing the switch to let its LED turn on allows you to use the knob to monitor the tape at variable speeds in search of a specific point. Turning the knob to the right of center rolls the tape in the forward direction, and turning it to the left of center provides reverse cueing. The further you turn it in either way, the higher the tape speed will be. The initial speed is 1/4 times normal play speed, and if you turn the knob all the way to the left or right, the tape will play at 8 times normal play speed.

Pressing the SHUTTLE switch during recording gets you out of record, allowing you to begin to "shuttle" the tape immediately.

SHUTTLE will automatically be disabled if you leave the knob at its center position for 10 seconds.

**32. Peak level meters**

Register the signal levels being fed to the outputs, the levels coming either from the inputs or the tape, as shown in the left column of this page.

**33. REC FUNCTION switches**

Put the corresponding tracks into Record Ready mode, or directly into Record if RECORD and PLAY are previously pressed.

The associated LEDs flash to indicate Record Ready, and turn on solid during Record.

#### 34. CHASE key

Lets the slave DA-88(s) chase and lock to the same ABS time point as the master. Once locked up, they will play, record, or fast-wind in sync in response to the commands from the master.

The installation of the optional SY-88 sync board allows the DA-88 to run in sync with VTRs or other ATRs (digital or analog). For more details, refer to the SY-88 manual.

#### 35. CLOCK switch

Selects the clock to which the deck will be referenced. If the DA-88 is used as a stand-alone deck, it has to be referenced to the INT(ernal) clock.

The **WORD** clock is used when making a digital copy between the DA-88 and other digital tape machines, or when letting them run in sync (the optional SY-88 Sync Board is required).

For the DA-88 to be slaved to VTRs, select **VIDEO** (the optional SY-88 sync board is required).

When one or more DA-88s are hooked up as the slaves, the **CLOCK** switch on them are locked out (all the associated LEDs turned off), and they are automatically referenced to the clock to which the master DA-88 is referenced.

The next two items can operate only when the optional SY-88 sync board is installed. For their functions, refer to the SY-88 manual.

#### 36. TC GENERATE switch

#### 37. TC REC key

### REAR PANEL

#### 38. REMOTE IN/SYNC IN and SYNC OUT jacks

When two or more DA-88s are hooked up, a sync signal and commands from the master's SYNC OUT jack are fed into the first slave's SYNC IN jack; and its SYNC OUT jack feeds the second slave's SYNC IN jack, and so on.

The optional RC-848 remote control unit may alternatively be connected to the SYNC IN jack. The remote can control a maximum of 6 DA-88s, separately.

*Use only the optional PW-88S sync cable for establishing the sync in and out connection.*

#### WARNING

Please use only TASCAM cables, as there are very specific cable requirements, these cables are specially configured for connection to REMOTE IN/SYNC IN, SYNC OUT, METER UNIT, TDIF-1 (DIGITAL I/O).  
(Do Not use standard computer cables.)

It is possible to damage certain internal components by the use of non TASCAM cables. If the use of non TASCAM cables causes or results in damaged this will void the Warranty.

#### 39. WORD SYNC IN and OUT jacks

The DA-88 can be referenced to the clock derived from the WORD SYNC IN for it to be slaved to other digital tape machines. Inversely, they can be slaved to the DA-88 by letting them be referenced to the clock the DA-88 transmits from its WORD SYNC OUT. (For the DA-88 and other digital machines to be synchronized, the optional SY-88 Sync Board is required.)

The clock the WORD SYNC jacks carries may also be used when making a digital copy between the DA-88 and other digital machines.

#### 40. REMOTE IN jack

For connection to the optional RC-808 basic remote transport control unit.

#### 41. REMOTE PUNCH IN/OUT jack

For connection to the optional RC-30P footswitch.

#### 42. MACHINE ID rotary switch

For two or more DA-88s to be synchronized, they have to be given their own ID (identification) numbers. Allot "0" to the master, "1" to the first slave whose SYNC IN is directly fed with the master's SYNC OUT; and, in a similar

#### Bescheinigung des Herstellers/Importeurs

Hiermit wird bescheinigt, daß der/die/das

#### TASCAM DA-88 DAT-Recorder

(Gerät, Typ, Bezeichnung)

in Übereinstimmung mit den Bestimmungen der

#### AMTSBLATT 163/1984, VFG 1045/1984, VFG 1046/1984

(Amtsblattverfügung)

funk-entstört ist.

Der Deutschen Bundespost wurde das Inverkehrbringen dieses Gerätes angezeigt und die Berechtigung zur Überprüfung der Serie auf Einhaltung der Bestimmungen eingeräumt.

#### TEAC CORPORATION

Name des Herstellers/Importeurs

way, allot "2" and upper numbers to the remaining slaves in sequence, in their order of SYNC IN/OUT connections. "11" and upper numbers are represented by alphabets ; "11" by "A," "12" by "B," and so on.

☞ *Don't assign the same ID number to two or more machines. This may cause incorrect functions to them.*

**NOTE**

When operating the MACHINE ID switch, make sure that the deck is turned off or it has no effect.

**43. METER UNIT connector**

Carries the output of eight channels and the power for driving eight of the twenty-four meters on the optional MU-8824 meter unit.

**44. DIGITAL I/O TDIF-1 port**

This serial interface carries all eight channel signals at one time, and allows digital dubbing between two DA-88s using the optional PW-88D dubbing cable.

For the DA-88 to be connected to other digital machines, the following optional accessories are available from TASCAM :

- IF-88AE : for connection to machines with AES/ EBU digital I/O or SPDIF port.
- IF-88SD : for connection to machines with SDIF-2 port.

**45. INPUTS**

**Jacks 1 to 8 :** receive unbalanced -10 dBV analog sources.

**Multipin connector :** receives balanced +4 dBm analog sources.

**46. OUTPUTS**

**Jacks 1 to 8 :** for connection to the unbalanced analog inputs of external equipment.

**Multipin connector :** for connection to the balanced analog inputs of external equipment.

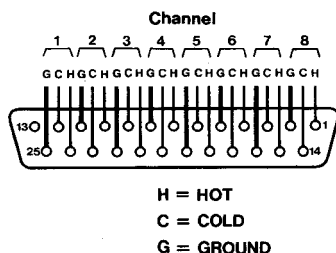

**Note for U.K. Customers**

**DO NOT cut off the mains plug from this equipment.** If the plug fitted is not suitable for the power points in your home or the cable is too short to reach a power point, then obtain an appropriate safety approved extension lead or consult your dealer.

If nonetheless the mains plug is cut off, remove the fuse and dispose of the plug immediately, to avoid a possible shock hazard by inadvertent connection to the mains supply.

If this product is not provided with a mains plug, or one has to be fitted, then follow the instructions given below:

**IMPORTANT.** The wires in this mains lead are coloured in accordance with the following code:

- GREEN-AND-YELLOW: EARTH
- BLUE: NEUTRAL
- BROWN: LIVE

**WARNING:** This apparatus must be earthed.

As the colours of the wires in the mains lead of this apparatus may not correspond with the coloured markings identifying the terminals in your plug proceed as follows.

The wire which is coloured GREEN-and-YELLOW must be connected to the terminal in the plug which is marked by the letter E or by the safety earth symbol  $\perp$  or coloured GREEN or GREEN-and-YELLOW.

The wire which is coloured BLUE must be connected to the terminal which is marked with the letter N or coloured BLACK.

The wire which is coloured BROWN must be connected to the terminal which is marked with the letter L or coloured RED.

When replacing the fuse only a correctly rated approved type should be used and be sure to re-fit the fuse cover.

IF IN DOUBT — CONSULT A COMPETENT ELECTRICIAN.

## Hookup

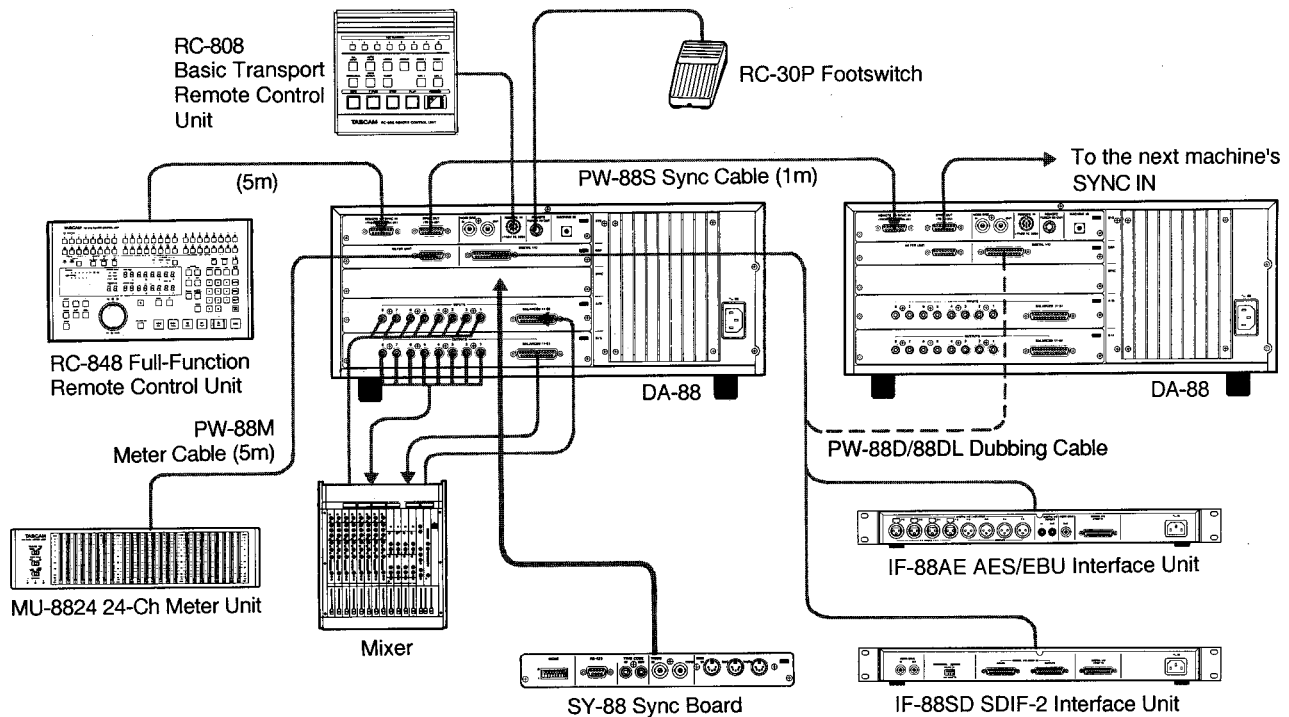

## Formatting a Tape

Before starting to record any audio program on a new tape, it should be formatted, i.e. it should be time-indexed and given tracking and other subcode data.

### NOTES

- Be sure to let formatting start from the very beginning of the tape.
- Once formatting starts, all transport control buttons except STOP are locked out. If you stop the tape before formatting is complete, reformat it from the beginning.
- Tapes once used for recording video cannot correctly be formatted. Don't try to format such tapes.

To format a new tape :

1. Switch on power to the DA-88.
2. Load a Hi8 tape into the DA-88.
3. Press **FORMAT**. Its LED will start blinking.
4. Press **FORMAT** again. Its LED will turn on solid showing that the deck is ready for formatting.
5. Press the **Fs** switch to select either of the two sampling rates available. Select 44.1 kHz if the recording will be used as a digital master for CD production. Or, select the professional standard 48 kHz rate for other applications.

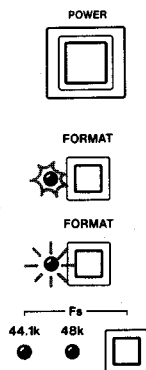

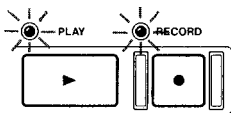

☞ Once formatting starts, you cannot change the sampling rate. If you notice that a wrong rate was selected after formatting starts, stop and rewind the tape to the beginning and select the correct rate before re-starting formatting.

6. Hold **RECORD** and press **PLAY** to let formatting start.

When the tape reaches the end and formatting is complete, it will automatically rewind, stopping at the beginning.

☞ Pressing any **REC FUNCTION** switch after once formatting starts lets audio be recorded on the corresponding track. But to insure against noise and discontinuities of absolute time data, we recommend that you format all tapes all the way to the end before using them for audio record.

☞ If you attempt to record additional material to augment the original and wish to format the tape from that intermediate point, be sure to sufficiently move back the tape beforehand to prevent an unformatted section being left in between.

#### NOTE

When the tape runs from the previously formatted part into the newly formatted part, there could be discontinuities of ABS time data. The transition could cause erratic sync if it happens when syncing. If audio data is present over the transition zone, noise could be heard. The best is format a tape from start to end without interruption.

## Audio Recording

### INITIAL RECORDING



1. Check to see that all connections are made correctly.
2. When all connections are checked OK, switch on power to the DA-88 and other elements of your system.
3. Load a Hi8 tape into the DA-88.

☞ Any other tape whatever cannot be loaded on the DA-88.

☞ If the tape has not been formatted already, refer to the section "Formatting a Tape."

4. If you want to record digital audio, press the **DIGITAL IN** switch to let its LED light.

If you want to record analog audio, the DIGITAL IN LED should be turned off.

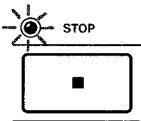
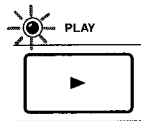
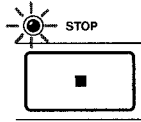
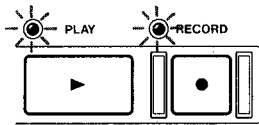

5. Check to see that **VARI SPEED** is NOT activated. If its LED is on, turn it off by pressing the switch.
6. Select the track or tracks to record on by pressing their **REC FUNCTION** switch.
7. If you intend to record analog audio, let the source start playing, and adjust *its output level controls* until the DA-88's meter peaks at the reference level of "0". If the OVER indicator lights, it shows distortion occurred.

If you intend to record digital audio, no level adjustment is required.

8. Hold **RECORD** and press **PLAY** to let recording start.
9. When recording is complete, press **STOP**.
10. To prevent recording from accidentally erasing, put the track(s) into Safe mode by pressing their **REC FUNCTION** switch again.

#### Playback

11. Check to see that the audio outputs are correctly connected to your monitor system, through a mixer or not.
12. Rewind the tape to the beginning of the recording you want to let play, then press **PLAY**.
13. To stop play (definitely or momentarily), press **STOP**.

#### Output Mode Selection

To use the digital outputs, hold down ▲ and press **DIGITAL IN** when the display is switched to ABS. "Digital" will appear momentarily on the display, showing the digital output mode is selected. Each time you press **DIGITAL IN** while holding down ▲, the output mode toggles "Digital" and "Analog." Revert to the analog output mode when you use the analog outputs.

## PUNCH-IN (INSERT) RECORDING

### Auto Punch In And Out

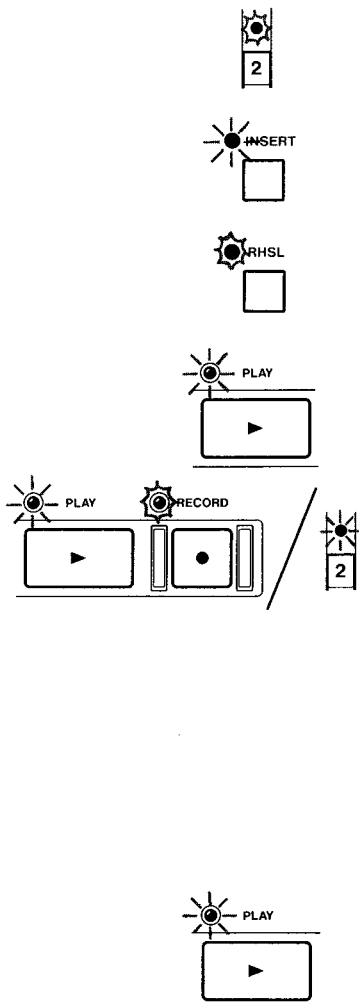

First check to see that the source is connected to the correct input jack. If you're punching into a track just recorded, there is no need of repatching.

### REHEARSAL FOR AUTO PUNCH IN AND OUT

During rehearsal, what you hear in the monitor mix and read on the level meters will be the same as during recording, but any signal won't be recorded on tape. So you can rehearse your punch-in as many times as you need without destroying the original take at all.

#### Initial Setting of Punch In and Out Points

1. Locate the tape to a point lower than the point where you want the track to punch into record.

2. Put the punch-in track into Ready mode by pressing its **REC FUNCTION** switch.

3. Press the **INSERT** switch to let its LED light.

4. Press the **RHSL** switch. Its LED will start blinking.

*☞ You cannot operate RHSL if REPEAT is activated.*

5. Press **PLAY** to let the tape start playing.

6. When the expected punch-in point is reached, hit **RECORD** (or press the optional RC-30P footswitch). This point on the tape is stored into memory.

You will continue to hear the tape. The monitor does not switch to Source (Input) because you are still in rehearsal setting mode.

7. When the expected punch-out point is reached, hit **PLAY** (or press the RC-30P footswitch). This point on the tape is stored into memory. The RHSL LED which was blinking will turn on solid.

8. After 3 seconds of postroll, the tape will automatically rewind, stopping at a point 5 seconds lower than the punch-in point you have specified in step 6.

9. Press **PLAY** to check the punch in and out points for accuracy.

When the punch-in point is reached the monitor will switch to Source, and will switch back to Tape at the punch-out point. After 3 seconds of postroll, the tape will rewind, stopping at the preroll start point.



**Preroll time :** It defaults to 5 seconds. If you want longer prerolls, hold ▲ or ▼ and press the other. The display will read "Pr. 00 05 00." Then, each time you press ▲, the display will increment by 1 second, up to 59 minutes, 59 seconds. To decrement the display, press ▼. You can hold the key to scroll through the numerals. After you have entered the desired time, press DISPLAY to switch the display back to its normal, ABS time display mode.

*☞ You cannot use the ▲ and ▼ keys to get access to the "Pr" display except when the RHSL is flashing or lights solid or the AUTO IN/OUT LED lights solid, and ABS time shows and the tape is stopped.*

The postroll time is fixed to 3 seconds.

- When the optional RC-848 remote control unit is connected to the DA-88, you can "fine tune" the postroll time as well.

#### Fine Tuning In and Out Points

10. Press the **DISPLAY** switch until the MEMO 1 LED lights. The display then shows the ABS time of your punch-in point. Then press the ▲ key to increment the punch-in point time, or press the ▼ key to decrement it. Each time either key is pressed, the ABS time will increment or decrement by 1 second.

To speed up the tuning, you can hold down either ▲ or ▼ and press **DISPLAY**. Each time you press **DISPLAY**, the next upper (left) two digits will fast increment.

11. Likewise, you can fine tune the punch-out point ; first press **DISPLAY** to let the MEMO 2 LED turn on, then change the display with ▲ and ▼.

12. Audition the new in and out points by pressing **PLAY**.

Repeat steps 10 and 11 until you are sure that the punch in and out points are correct.

**Entering a Crossfade Time :** It defaults to 10 msec. If you want longer crossfades, hold the ▼ key and press DISPLAY. "C.FADe 10" will show. Then, each time the ▲ key is pressed, the fade time will increment by 10 msec, up to 90 msec. The ▼ key decrements the time, down to 10 msec.

After you have entered the desired time, press DISPLAY again.

**To reset the crossfade time to 10 msec :** Hold ▲ or ▼ and press the other when "C.FADe" shows in the display.

**To check the current crossfade time :** Hold ▼ and press DISPLAY at any time when ABS time shows.

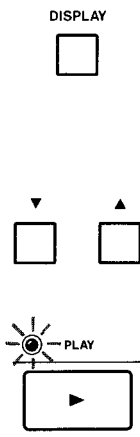

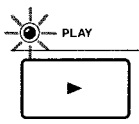
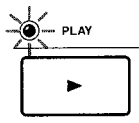
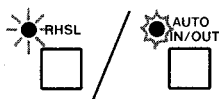

## Manual punch in and out

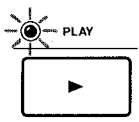

## Punch-in Rehearsal

- Practice the performance until you are sure that you will get it right when actually recording. Remember, once you punch-in over existing material, that original signal is erased !

## Actual, Auto Punch In and Out

Once you're sure your performance and the in/out points selected are correct, you're ready to actually punch into record. The RHSL LED should be on solid. All tracks should be in SAFE mode except the one you intend to record.

- Press **AUTO IN/OUT**. Its LED will start blinking.

- Press **PLAY**.

The tape will punch into record, and punch out of record, as programmed; and after 3 seconds of postroll, the tape will rewind, stopping at the preroll start point, all as you have anticipated during Rehearsal.

## Review

- Press **PLAY** to check if the new recording sounds right.

## To exit Auto In/Out mode :

Press **CLEAR**. The AUTO IN/OUT LED will turn off, and the RHSL LED as well.

To accommodate various situations the DA-88 allows you to let the tape manually punch into and out of record, too.

There are three ways to punch into record mode.

## RECORD-triggered punch-in

- Locate the tape to a point a few seconds lower than the expected punch-in point.
- Put the punch-in track into Ready mode by pressing its **REC FUNCTION** switch.
- Press **INSERT** to let its LED turn on.
- Press **PLAY** to let the tape start playing.

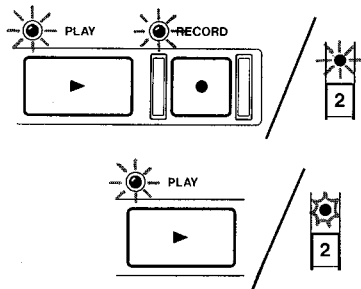

5. At the desired punch-in point, hit **RECORD**. The REC FUNCTION indicator which was blinking will turn on solid.

6. Hit **PLAY** to punch out of record. The tape will resume playing and the REC FUNCTION indicator will start blinking as before.

### REC FUNCTION-triggered punch-in

1. Check to see that all the **REC FUNCTION** indicators are off.
2. Press **INSERT** to turn on its LED.
3. Locate the tape to a point a few seconds lower than the expected punch-in point.
4. Hold **RECORD** and press **PLAY** to let the tape start playing in Record Ready mode.
5. At the desired punch-in point, hit the punch-in track's **REC FUNCTION** switch.
6. At the punch-out point, hit the same **REC FUNCTION** switch again. The transport will go into Play mode.

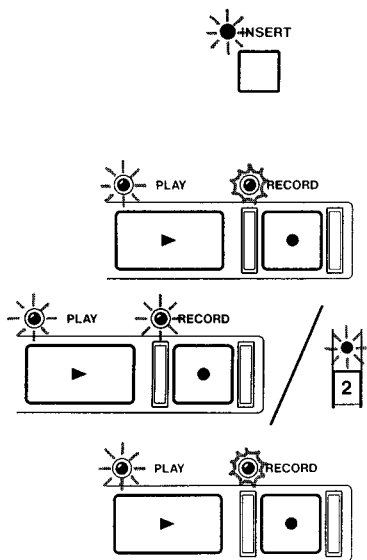

### Footswitch-triggered punch-in

The optional **RC-30P** footswitch allows you to achieve no-hands punch-in and out.

1. Plug the RC-30P footswitch into the REMOTE PUNCH ON/OUT jack on the deck's rear.
2. Locate the tape to a point a few seconds lower than the expected punch-in point.
3. Put the punch-in track into Ready mode by pressing its **REC FUNCTION** switch.
4. Press **INSERT** to let its LED light.
5. Press the **footswitch** to start hearing the track.
6. At the desired moment, press the **footswitch** again to punch the track into record.

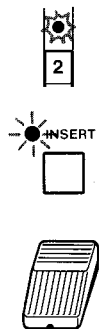

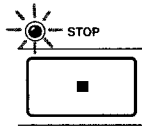

7. To punch out of record, press the **footswitch** again.
8. To stop the tape, press **STOP**.

## BOUNCING TRACKS (PING-PONG)

In this example, we will "bounce" or combine material from tracks 1-4 onto empty track 8.

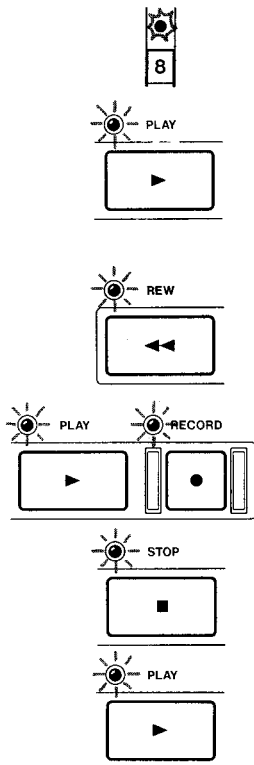

1. Connect outputs 1-4 of the DA-88 to inputs 1-4 of your mixer, and connect group out 1 of the mixer to input 8 of the DA-88.
2. Set the mixer controls as required (assign channels 1-4 to group out 1, bring up the group 1 monitor level control, etc).
3. Press the **REC FUNCTION** switch for track 8 to put this into Ready mode. All other tracks should be in Safe mode.
4. Locate the tape to the beginning of the selection, then press **PLAY**.
5. Slowly increase the group 1 fader until meter 8 peaks at 0 dB. Use the channel faders (and EQ controls) to set each track's relative level for the desired balance.
6. When the record level setting is complete, rewind the tape back to the beginning of the selection.
7. Hold **RECORD** and press **PLAY**. Tracks 1-4 will be mixed into track 8.
8. At the end of the selection, press **STOP**, and rewind the tape to the beginning of the recording just done.
9. Put track 8 into Safe mode by pressing its **REC FUNCTION** switch again, then press **PLAY** to audition the mix on track 8. If track 8 does not sound right, make the necessary corrections and redo from the beginning.

### Repeat bouncing :

Once you are totally satisfied with the mix on track 8, you can record new material on tracks 1-4, then bounce them onto track 7 or any other empty track the same way you bounced onto track 8.

## ENTERING A TRACK DELAY TIME

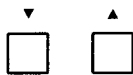
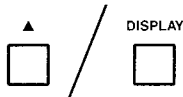

You can let the output of a specific track lag behind that of others by a maximum of 7200 samples (Fs). This is like an offset you may want to enter so that one transport will sync to the master with a distance maintained between them.

1 sample corresponds to 22.7 microseconds at 44.1 kHz, and to 20.8 microseconds at 48 kHz.

1. When the display shows ABS time, hold the ▲ key and press **DISPLAY**. The display will read "dl. tr SEL," prompting you to select the track you want to lag.
2. Press **REC FUNCTION** of the desired track. The display will now read "tr 1 00 00" (if you pressed REC FUNCTION 1), prompting you to specify how many samples the track will lag.
3. Use the ▲ and ▼ keys to enter the desired numerals. Each time you press either key, the display will increment or decrement in 1 sample steps, up to 7200 samples/down to -200 samples. You can hold the key to scroll through the numerals.

Repeat steps 2 and 3 for other tracks if necessary.

4. To complete the procedure, press **DISPLAY**. ABS time will show again.

**To reset the current delay time**, hold ▲ or ▼ and press the other at any time when ABS time shows.

**To check the delay time you've entered**, hold ▲ and press **DISPLAY**, then press the necessary channel's **REC FUNCTION** at any time when ABS time shows.

## Variable Speed Playback

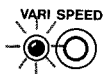

During play (or before starting it) you can change the tape speed up to +/- 6.0% in 0.1 % steps as follows.

1. Press **VARI SPEED** to let its LED turn on. "PITCH" will show in the display.
2. Press the ▲ key to speed up the tape, or press the ▼ key to lower the speed.

To defeat all pitch changes, hold either ▲ or ▼ and press the other, whatever the display and the transport mode.

# Autolocation Controls

## □ Setting Locating Points

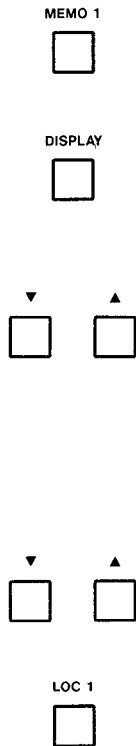

Two locating points (MEMO 1 and MEMO 2) can be established on a given tape.

### To set MEMO points :

Press MEMO (1 or 2) at the desired point during Play, or during Stop if the tape is at the point you want to specify as a locating point.

### To check MEMO points :

Press the **DISPLAY** switch (when the tape stops or is running) until the MEMO 1 (or 2) LED lights. The display is now showing the location stored into the corresponding register.

### To fine tune MEMO points :

When the MEMO point you want to fine tune is showing in the display, press ▲ to increment the numbers shown, or press ▼ to decrement them.

To speed up the tuning, you can hold down either ▲ or ▼ and press **DISPLAY**. Each time you press **DISPLAY**, the next upper (left) two digits will fast increment.

### To clear MEMO points :

Hold either ▲ or ▼ and press the other. The locating point currently shown in the display is erased from memory, as confirmed by "00:00:00:00" appearing instead.

### To autolocate the tape to MEMO points :

Press **LOC 1** to locate the tape to the MEMO 1 point. Press **LOC 2** to locate the tape to the MEMO 2 point.

At the end of locating functions the tape will stop unless **AUTO PLAY** is previously pressed.

*☞ The LOC keys cannot operate during rewind, punch-in/out process, or when two or more DA-88s are hooked up and the slaves are chasing the master.*

## □ Repeat Play

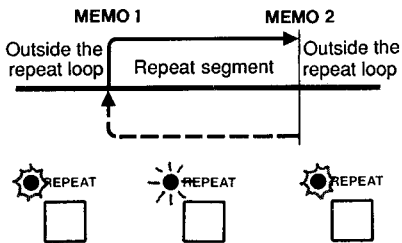

Pressing **REPEAT** lets the tape play between MEMO 1 and MEMO 2 points over and over.

The MEMO 1 point should not be lower than the MEMO 2 point. The DA-88 understands the lower MEMO point as the start point of loop, and the higher point, as the end.

### NOTE

There must be at least 5 seconds between the two MEMO points.

**To interrupt momentarily repeat play, press STOP.** Press **PLAY** to resume play.

**To exit repeat mode, press REPEAT.**

- If only either MEMO 1 or MEMO 2 point is established, the tape will repeat between that MEMO point and the counter zero point.

- Pressing any transport control button during repeat play activates the function pressed, and repeat play will start again if you —:

Press **AUTO PLAY** then **LOC** (whether 1 or 2) when the tape is at any point.

OR

Press **LOC** when the tape is at any point, and, when the tape stops at the beginning or end of loop, press **PLAY**.

OR

Press **PLAY** when the tape is within the loop or at a lower point than the beginning of the loop.

## Multiple-DA-88 System

### SYNCHRONIZATION

You can set up a maximum of 16 DA-88s for 128 tracks to let them behave in sync with sample accuracy, one DA-88 serving as the master, and all others as slaves, this without having to use any external synchronizer, but simply by connecting their SYNC IN and OUT jacks in series.

#### NOTES

- To synchronize multiple DA-88s, it is imperative that tapes in use are previously formatted and have ABS time data.
- You cannot synchronize tapes if they have been formatted for different sampling rates.
- When multiple DA-88s are hooked up, be sure to keep all of them turned on, whether they are all actually in use or not. If some DA-88s are in record or play and you turn any others on or off, the recording or playing tapes can run irregularly.

#### Connections

Before anything else, check to see that all elements of your system are turned off. Diagram shows a three-DA-88 system as an example.

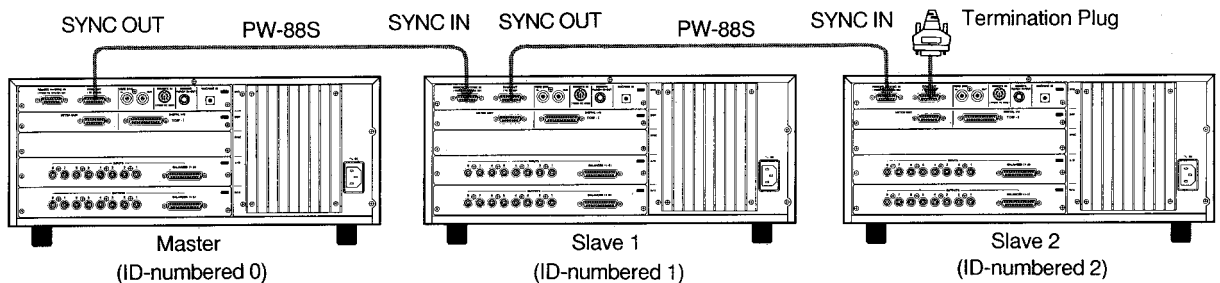

1. Connect one end of the optional PW-88S cable to the master's SYNC OUT, and the other end of the cable to the slave's SYNC IN.

If there are more slaves, connect the second slave's SYNC OUT to the third slave's SYNC IN, and the third slave's SYNC OUT to the fourth slave's SYNC IN, and so on.

☞ Use only the optional PW-88S cables to cascade multiple DA-88s. Any other cables may seriously damage the machines.

#### WARNING

Please use only TASCAM cables, as there are very specific cable requirements, these cables are specially configured for connection to REMOTE IN/SYNC IN, SYNC OUT, METER UNIT, TDIF-1 (DIGITAL I/O). (Do Not use standard computer cables.)

It is possible to damage certain internal components by the use of non TASCAM cables. If the use of non TASCAM cables causes or results in damaged this will void the Warranty.

#### Allotting ID (Identification) numbers

2. Insert the termination plug into the last DA-88's SYNC OUT connector. This plug is supplied with the RC-848/PW-88S.

#### NOTE

Do Not forget to attach the termination plug to the SYNC OUT terminal of the last Slave machine in multiple DA-88 synchronization system or correct operation is not ensured.

In passing when hooking up only a single DA-88 to the RC-848 remote, the plug must be inserted into that machine.

3. Locate the **MACHINE ID** rotary switch on the rear panel of the master DA-88, and set it to "0". Similarly, assign "1" to the first slave machine, "2" to the second slave, and so on, in their order of SYNC IN/OUT connections.

☞ Operating the MACHINE ID switch when the machine is turned on has no effect at all.

#### To let slaves chase and lock to the master :

4. Turn on the DA-88s (and other equipment as well as required).
5. Press **CHASE** on each of the slave machines. They will all be located to the same time point as the master.
6. Press a transport control button whatever on the master machine. The slave transports will go into the same mode as the master.

You can enter an offset so slave DA-88s lead or lag the master, each by a different number of hours, minutes, seconds, and frames.

Press **DISPLAY** on your slave DA-88 until "00000000" shows and the **OFFSET** indicator lights, then you can use its ▲ and ▼ keys to enter the desired offset time in 1 frame steps, up to +/-1 hour, 00 minute, 00 second, 00 frame.

To speed up the number entry, you can hold down either ▲ or ▼ and press **DISPLAY**. Each time you press **DISPLAY**, the next upper (left) two digits will fast increment.

**To disable any offset you've entered**, hold ▲ or ▼ and press the other.



#### ❑ Entering an offset

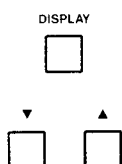



□ Digital dubbing

With digital recording, how many times dubbing is repeated, no hiss or distortion is added ; you can copy important multitrack tapes as many times as you need to create work tapes or copies for distribution without having to worry about any deterioration.

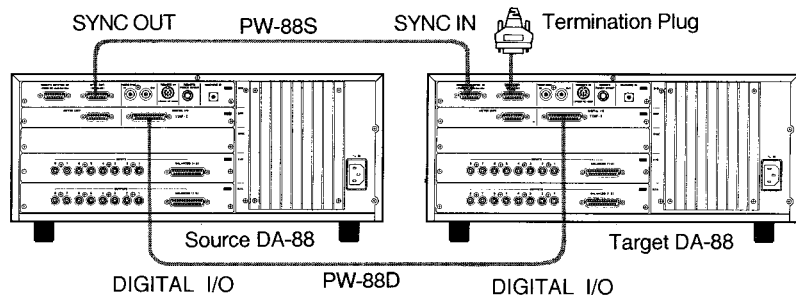

To make a digital copy between DA-88s :

1. Making sure that every equipment of your system is turned off, connect the source machine's DIGITAL I/O port to the target machine's DIGITAL I/O port by means of the PW-88D cable.
2. After having made the necessary connections, turn on the whole system.
3. Put the master (source) machine into the Digital output mode as described on page 15.
4. Load the master multitrack tape on the source machine, and an already formatted blank tape on the target machine.
5. Check to see that all the REC FUNCTION switches on the source machine are turned OFF.
6. Check to see that all the REC FUNCTION switches on the target machine are turned ON.
7. Press **CHASE** on the target machine, so its tape will be located to the same time point as the source machine.
8. Hold **RECORD** and press **PLAY** on the source machine to let the master multitrack tape start playing. The target machine will automatically go into record mode, and the master tape will be copied on the target tape.

Use the IF-88AE interface unit if you want to make a digital copy between the DA-88 and other digital machines with AES/EBU Digital I/O or SPDIF port. Or use the IF-88SD interface unit for transferring data between the DA-88 and other digital machines with SDIF-2 port. Both units are optionally available. Once you have connected them, you can copy digital audio from one to the other machine by following the same procedure as for normal digital audio recording.



Whichever output mode you select (Digital or Analog), audio data is available at both the digital and analog outputs at one time. But remember the following :

In the Analog output mode, the analog outputs are timed to compensate for the D/A conversion time as well as the anticipatory A/D conversion time (42 samples in total as shown). But this in turn disturbs the digital output timing. On the other hand, in the Digital output mode, the analog outputs will lag because this mode disables the compensation circuit so that the digital outputs are timed as it should.

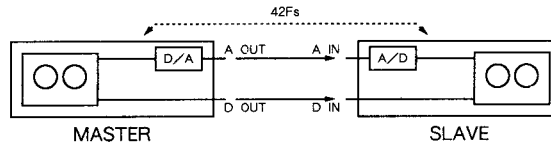

## Error Messages

### *E.C.L.O.C.*

No clock is coming in. Or, the CLOCK switch is not set to match an incoming clock. Check also if the slave machines (ID-numbered 1-15) are correctly connected in series through their SYNC IN/OUT connectors, and if the master is ID-numbered 0.

### *E.T.C.U.T.*

The tape has broken. The only remedy is replacement of the tape.

### *E.d.i.o.*

The DIGITAL I/O port is accidentally unplugged.

### *E.d.E.*

Condensation occurred on the head drum. Leave the machine for 1 or 2 hours with the power switched on until it stabilizes at the temperature of its operating environment.

### *E.H.I.-B.t.*

A different tape from the Hi8 is inserted. Use Hi8 tapes only.

### *E.t.h.i.n.t.*

The tape inserted is too thin (less than 8  $\mu$ m). Use P6/E6-120 (or P5/E5-90) or shorter tapes.

### *S-Err 8*

This shows the incident of error in the mechanics (the "8" is variable).

If this message appears, switch the power off, then switch it on again. If the message does not go out, repeat the on/off switching or try ejecting and reinserting the tape several times. If all attempts are of no avail, please contact TASCAM or your nearest TASCAM dealer.

### WARNING LED

This indicator lights to indicate the following :

- Condensation on the head drum
- Tape has broken
- DIGITAL I/O port accidentally disconnected
- External clock not coming in correctly
- No time code plugged in (when the optional SY-88 is installed)
- Time code setting not matched the type of incoming code (when the optional SY-88 is installed)

If the indicator lights, check to see whether error messages specify the problem in the display.

### TEAC CORPORATION

Musashino Center Bldg., 1-19-18, Nakacho, Musashino-shi, Tokyo 180, Japan Phone: (0422) 52-5081

### TEAC AMERICA, INC.

7733 Telegraph Road, Montebello, California 90640 Phone: (213) 726-0303

### TEAC CANADA LTD.

340 Brunel Road, Mississauga, Ontario L4Z 2C2, Canada Phone: 905-890-8008

### TEAC UK LIMITED

5 Marlin House, Marlin Meadow, The Croxley Centre, Watford, Herts. WD1 8YA, U.K. Phone: 0923-819631

### TEAC DEUTSCHLAND GmbH

Bahnstrasse 12, 65205 Wiesbaden-Erbenheim, Germany Phone: 0611-71580

### TEAC FRANCE S.A.

17, Rue Alexis-de-Tocqueville, CE 005 92182 Antony Cedex, France Phone: (1) 42.37.01.02

### TEAC BELGIUM NV/SA

143C Woluwelaan, 1831 Machelen-Diegem, Belgium Phone: (02) 725 6555

### TEAC NEDERLAND BV

Perkinsbaan 11, 3439 ND Nieuwegein, Nederland Phone: 03-402-30229

### TEAC AUSTRALIA PTY., LTD. A.C.N. 005 408 462

106 Bay Street, Port Melbourne, Victoria 3207, Australia Phone: (03) 646-1733

### TEAC ITALIANA S.p.A.

Via C. Cantù 5, 20092 Cinisello Balsamo, Milano, Italy Phone: 02-66010500